

**SUSHANTI INFRASTRUCTURES**



# COMPANY OVERVIEW

---

## About Us

At Sushanti Infrastructures, we take immense pride in being a world class leading name in the manufacturing of cutting-edge scaffolding and steel shuttering equipments.

With our manufacturing unit strategically located in North India, near Chandigarh, we have consistently delivered exceptional solutions to the construction industry. Our commitment to quality, innovation, and customer satisfaction sets us apart as a trusted partner for top construction companies.

# OUR EXPERTISE

With years of experience and a deep understanding of the construction industry, Sushanti Infrastructures has established itself as a reliable supplier of scaffolding and steel shuttering equipment.

Our clientele includes esteemed names like L&T, DLF, NCC, Shapoorji Pallonji, Omaxe, and many others. This association is a testament to our dedication to providing world-class products that meet the most stringent industry standards.

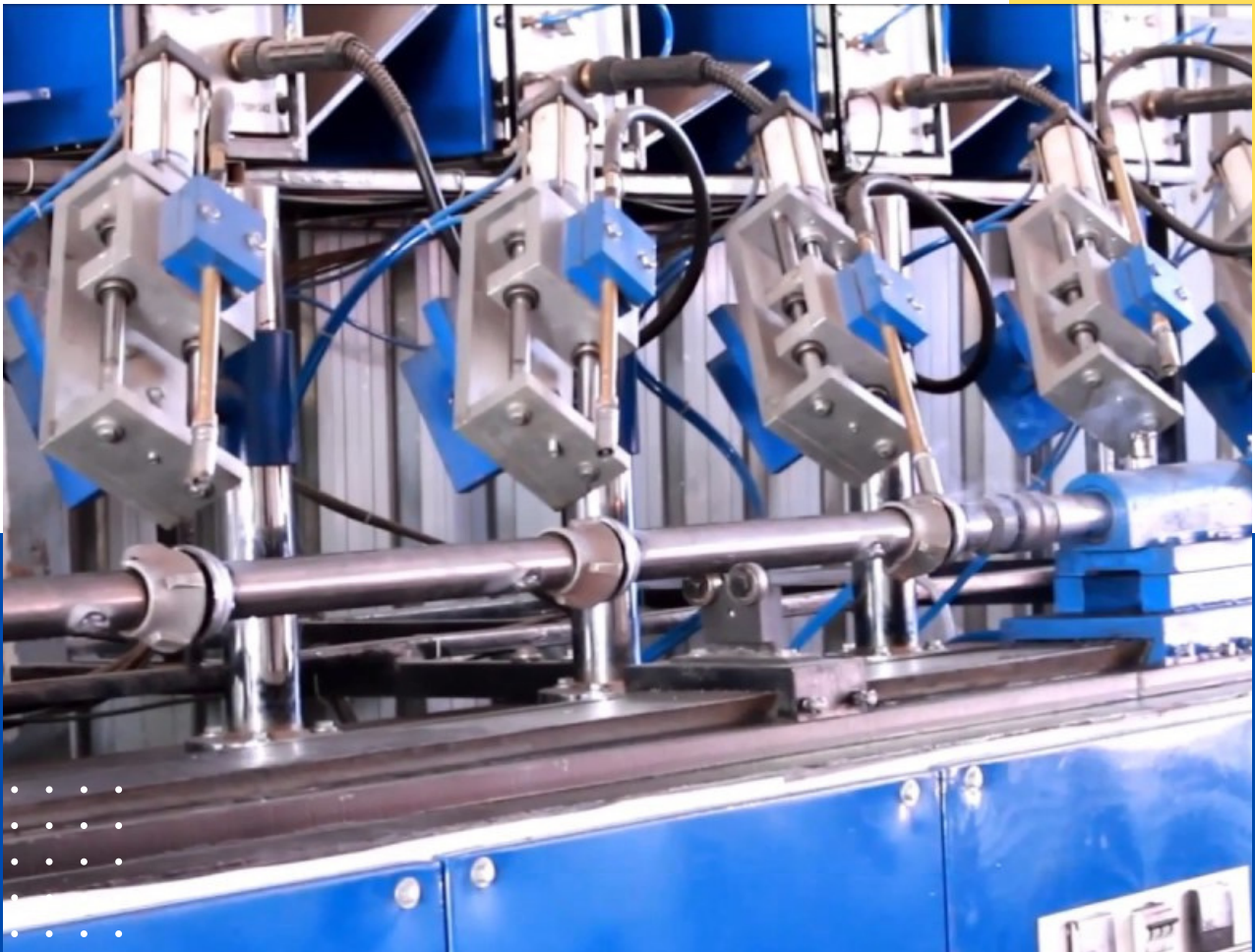

# QUALITY AND EXCELLENCE

At the heart of Sushanti Infrastructures is an unwavering commitment to quality and excellence. We believe that the foundation of any successful construction project lies in the reliability and durability of the equipment used. Therefore, we ensure that every product that leaves our facility is crafted with precision and adheres to the highest quality benchmarks. Our materials undergo rigorous testing to guarantee their performance even under the most demanding conditions.



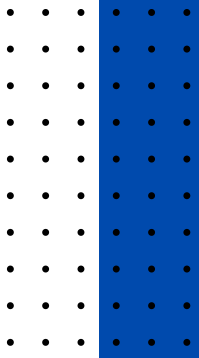

## COMPETITIVE ADVANTAGE

- Sushanti Infrastructures is known not only for its exceptional quality but also for its competitive pricing. We understand the importance of cost-effectiveness in the construction industry without compromising on the quality of materials. This balance between affordability and excellence has positioned us as a preferred choice for construction companies seeking reliable equipment solutions.

## RANGE OF ACCESSORIES

- We take pride in offering a complete range of scaffolding accessories to complement our core products. From couplers and clamps to platforms and safety features, our comprehensive lineup ensures that our clients have access to all the components necessary for a seamless and secure construction process.

# PRODUCTS

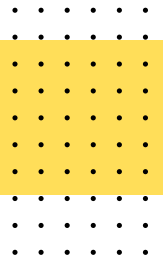

## Cuplock System

Cuplock scaffolding system uses metal cups to lock horizontal and vertical pipes together. Because of its unique locking mechanism, it is an easy to set up system that is fast and economical.



## Scaffold Prop

Scaffolding prop is a height adjustable telescopic tubular steel piece used as a temporary support. The safe working load (SWL) that each Prop can bear depends on the size.



## Vertical Cuplock

Vertical tubes that use lower fixed cups at standard intervals with rotating cups on the top which will lock the horizontal ledger blades.

# PRODUCTS

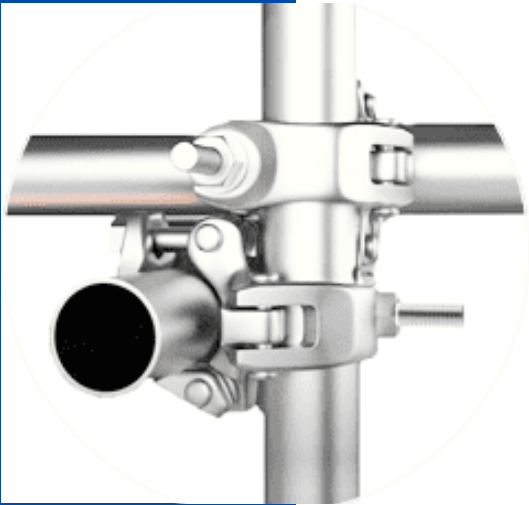
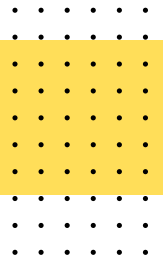

## Tube & Clamp

Scaffolding type that consists of steel tubes and clamps (couplers). These scaffolds can be assembled in multiple directions, making them an excellent option for work surfaces with irregular dimensions.

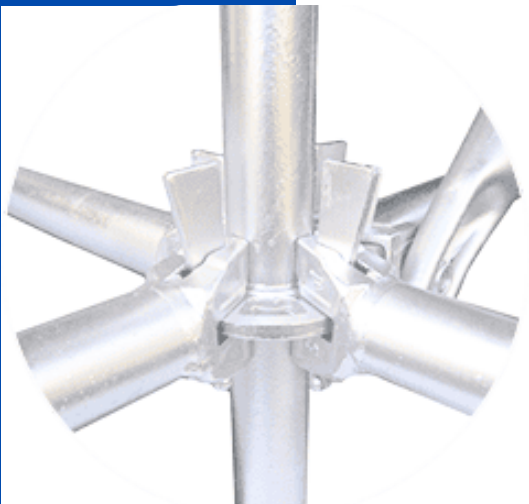

## Ring Lock

Ring lock, also known as wedge lock, circular lock, disc lock, all round scaffolding is a type of modular scaffolding mainly used at industrial and commercial projects.



## Kwikstage Scaffolding

Kwikstage is a style of modular scaffolding, the name of which derives from 'quick stage,' reflecting how quickly scaffolders can assemble and disassemble it.

# PRODUCTS

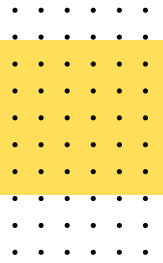

## Base Jack

Adjustable Solid Base Jack are used for levelling of scaffold structure from base. Electro Galvanised available on request.



## U Jack

Adjustable Solid U Head Jack are used for levelling of upper beam/ slab structure from top of scaffold structure. Electro Galvanised available on request.



## Horizontal Ledger

Horizontal ledger tubes have forged blade ends that allows simple and quick assembly. The blade ends of the horizontals fit into the cup of the vertical tube, ensuring a strong assembly.

# PRODUCTS

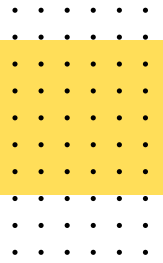

## Planks

Steel planks or battens are a light weight and non-slip work surface. Made from a continuous pre-galvanised steel sheet, they are pressed to a hollow shape.



## Tie Rod & Wingnut

Tie-Rod Winged Nut is a knock-on wing nut which is used in conjunction with waller plates to secure the bar in formwork applications. It is the compression nut of tie-rod shaft.



## Clamps

Different type of Scaffolding clamps (Putlog, sleeve, beam, swivel, right angle etc.) are metallic devices that are used to tie pipes in order to secure those pipes in place so that they don't displace or slip away.

# PRODUCTS

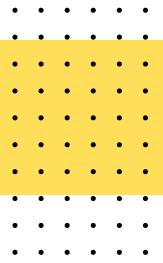

## Swivel Coupler

Swivel Coupler connects two Scaffold tubes at any angle. Electroplated finish. Hot Dip Galvanized finish available on request.



## Prop Sleeve

Prop Sleeve and nut used in outer pipe of prop jack for adjusting the height. Hot Dip Galvanized finish available on request.



## Nut Bolt

Nut and Bolts of different sizes are used in various construction activities specially in scaffolding and formwork.

# PRODUCTS

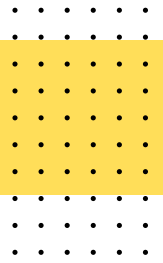

## Top Cup

Top cup is circular cup-node point that allows up to 4 horizontally connected scaffold ledger blades in a single installation.



## Ledger Blades

Ledger blades are welded on both ends of horizontal scaffold ledger pipes to tie it with vertical scaffold pipes.



## Base Plate

Base plates, also referred to as sole plates, are attached at base for load-bearing. The spigot is drilled to allow a tight bolt to be inserted if necessary

# PRODUCTS

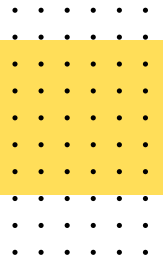

## U Head

U Head is welded over jack rod or pipe on upper side to give support to beam/slab structure on top of scaffold structure. Electro Galvanised available on request.



## Prop Nut

Prop nut used on the prop sleeve in outer pipe of prop jack for adjusting the height of inner pipe. Hot Dip Galvanized finish available on request.



## Bottom Cup

Bottom cup is circular welded on equal intervals on vertical cuplock pipe that allows up to 4 horizontally connected scaffold ledger blades in a single installation.

# GET IN TOUCH

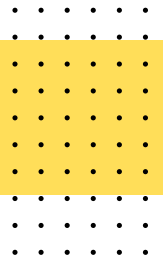

Whether you're a construction industry giant or a burgeoning enterprise, Sushanti Infrastructures welcomes you to explore our world-class offerings. Join hands with us to elevate your construction projects with equipment that mirrors your dedication to quality and precision. Contact us today to discover how we can collaborate for a brighter, stronger, and safer future in construction.



# CONTACT US



## SUSHANTI INFRASTRUCTURES

Plot No. 23, Godown Area, Sanouli, Zirakpur  
Near Chandigarh, Punjab India 160104  
[sushantiinfrastructures@gmail.com](mailto:sushantiinfrastructures@gmail.com)  
+91-9501960100

---